

Typical Cavity Block Wall Cons:
 19 Render Finish on
 100 Conc Block Outer Leaf
 110 Cavity with 60 Insulation
 100 Conc Block Inner Leaf
 12.5 Internal Plaster Finish

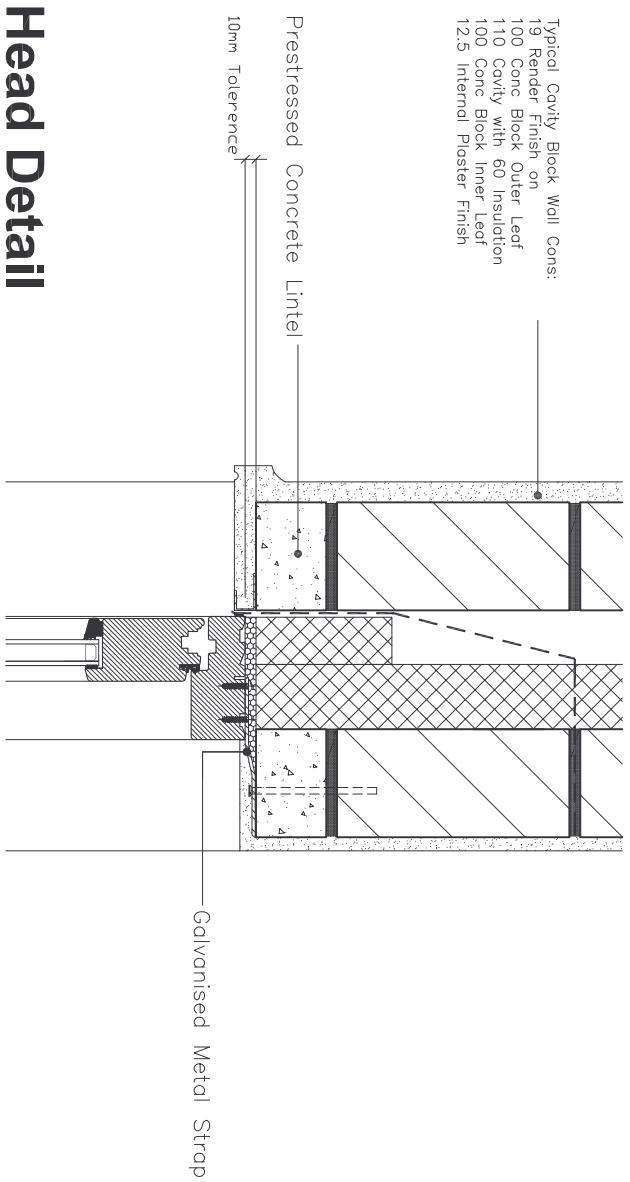

Head Detail

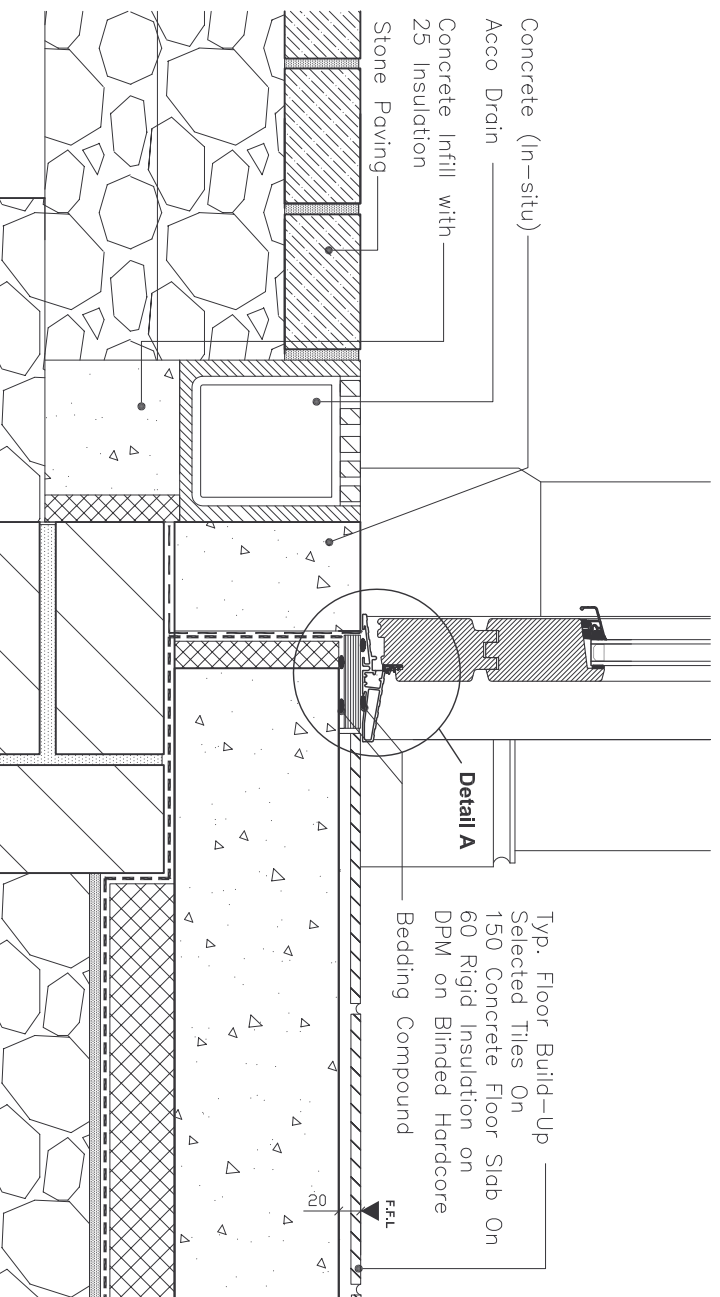

Low Level Alu. Threshold: Outward Opening

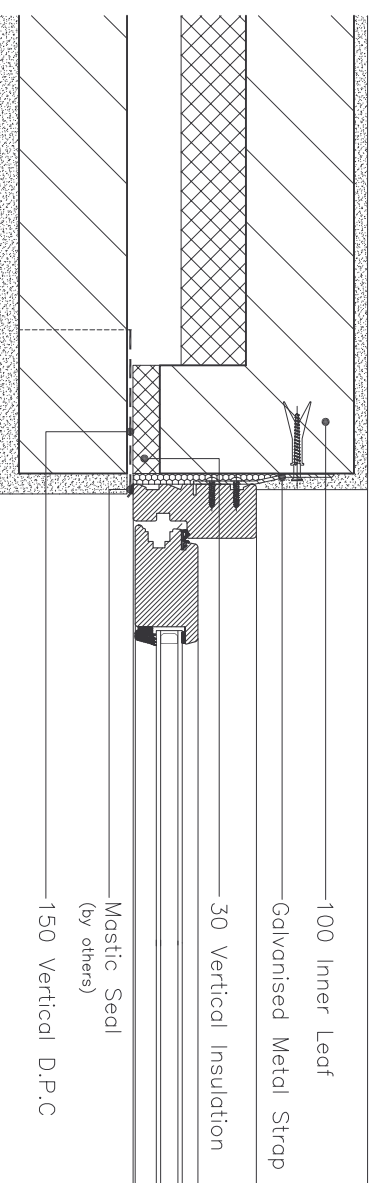

Jamb Detail

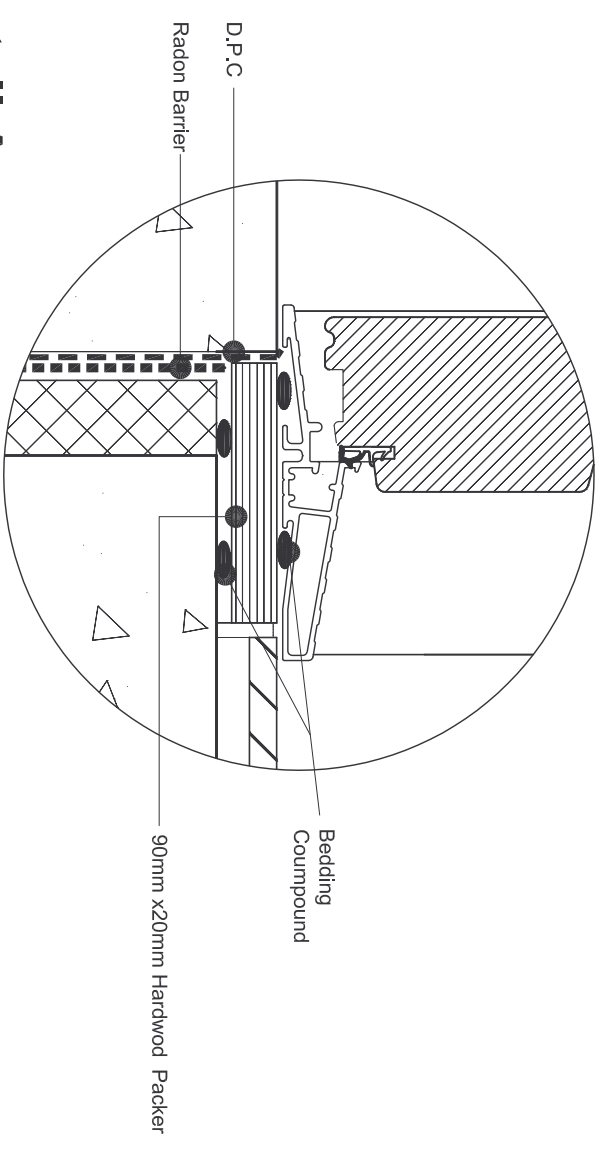

Detail A:

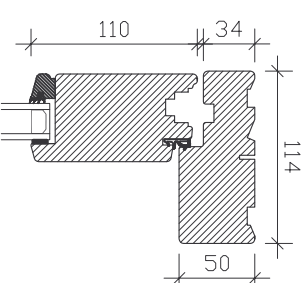

HEAD:
OPENING SASH

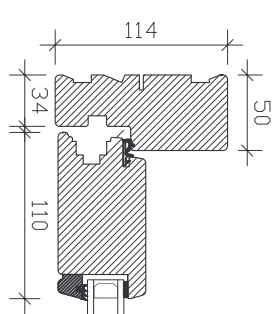

JAMB:
OPENING SASH

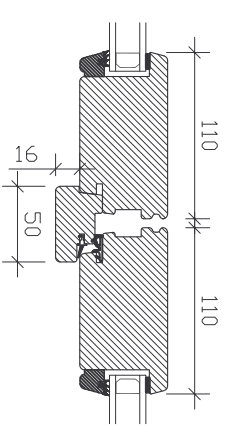

MULLION:
OPENING SASH

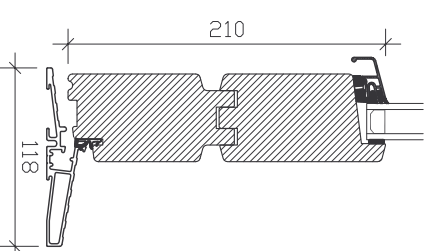

THRESHOLD:
LOW LEVEL ALU.
OPENING SASH

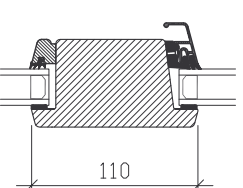

TRANSOM:
FIXED SASH

Profile Sections



CARLSON

G1, Calmount Park, Ballymount, D12
 TEL: 00 353 1 462 5777 FAX: 00 353 1 462 5737
 WEB: www.carlson.ie EMAIL: info@carlson.ie

DETAIL 152: CAVITY WALL RENDER